

Gas Discharge Tubes

H5R16-800L

1: Applications

- AC Power line L-N applications
- Class I and Class II Surge protection

2: Dimension in mm

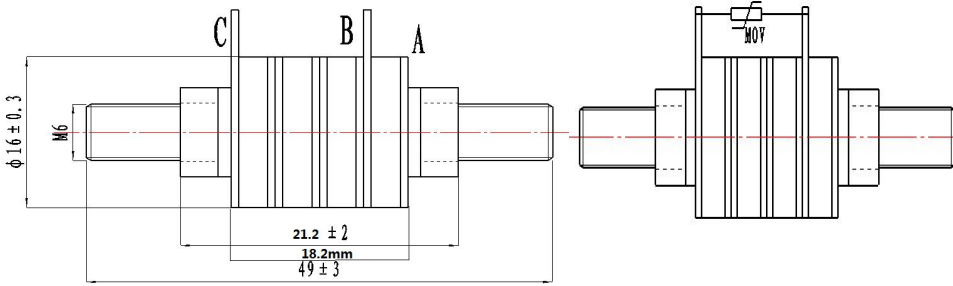

Specification of H5R20-800L

Nominal Dc spark-over voltage @ 100V/s	A-B >600V	
	A-C >600V	
Maximum impulse spark-over voltage @ 1.2/50μs,6KV	A-B <1500V	
	A-C(Add MOV) <1500V	
Response time	50ns	
Insulation resistance @250V	1GΩ	
Class I according to IEC 61643-11		
Max continuous operating voltage at 50/60 Hz	Uc	320V
Nominal discharge current 8/20μs	In	30KA
Impulse current 10/350μs	Iimp	12KA
Follow Current at 50/60Hz at 320V	If	500A
Class II according to IEC 61643-11		
Max continuous operating voltage at 50/60 Hz	Uc	320V
Nominal discharge current 8/20μs	In	30KA
Maximum discharge current 8/20μs	I _{max}	60KA
Follow Current at 50/60Hz at 320V	If	500A
Weight	~ 21g	
Delivery time	25days	
Voltage protection level	<2KV	
Quantity of electric charge	7.5As	
Quantity of electrodes	5PCS	
Marking, Green	800 YY	800 - Nominal voltage YY - Year of production

3:Application Figure

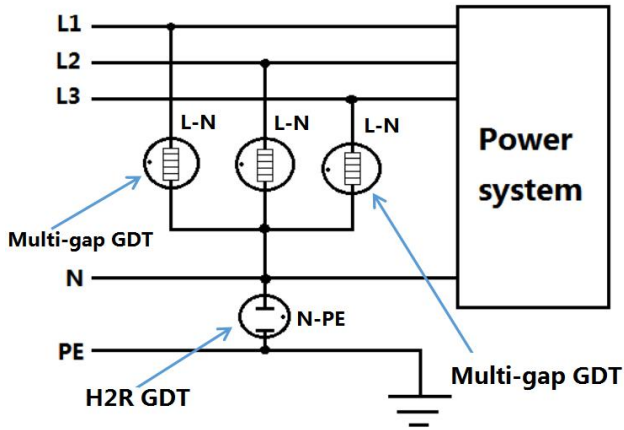

What can we do for our GDT?

- 1: We Can customize voltage: 500V,800V...etc
- 2: We Can developed low impulse GDT
- 3: We Can customize $U_c, I_n, I_{max}, I_{imp}, I_f, TOV$.
- 4: We Can developed cut off follow current 100A within 1 cycle when passing zero under AC260V(50Hz)
- 5: We Can customize multi-gap GDT used in DC or AC(L-N) over voltage protection
- 6: We Can customize GDT shape, marking, special Lead wire
- 7: We Can surpass our GDT competitors, help you pass the GDT test project & improve the GDT you currently use.
- 8: We can provide fast GDT delivery, Solve your GDT delivery time problem
- 9: We can help you analyze the competitor's parameters and tell you our perfect replacement GDT part number.

GDT H6R20-800L



MOV



SPD